



MARIANO MARCOS STATE UNIVERSITY

Bids and Awards Committee

INVITATION TO MAKE AN OFFER: Negotiated Procurement

2022-029-2

THE PROJECT: Replacement of Roofing and Ceiling at LHS Guidance Office
Project Location – MMSU-CTE, City of Laoag, Ilocos Norte
Number of Working Days: 21 calendar days
ABC: P175,250.84

1. The Mariano Marcos State University (MMSU), with offices at Quiling Sur, City of Batac, Ilocos Norte, invites the public to make an offer to furnish all labor, materials, tools and equipment necessary and proper for the implementation of the above Project as per approved designs, plans and drawings.
2. This process is in accordance with Section 53 of R.A. 9184, the Government Procurement reform Act and Section 53.9 of the Implementing Rules and Regulations where interested and qualified contractors are to submit proposals.
4. The offer must be in writing submitted at the address below not later than 5 days together with the following documents:
 - a) The amount of the offer in writing duly signed by the person making the offer, indicated in numbers and figures.
 - b) The particulars of the offer as to labor, materials, tools, equipment and other work details.
 - c) Documents in support of the legal, technical and financial capability of the person making the offer, which documents shall be confirmed and verified (3 copies).
5. It is understood that any offer may be accepted or rejected, or the process invalidated, at any time prior to contract award, without liability to anyone.
6. Documents for this procurement may be secured from the MMSU BAC Secretariat at the address below or downloaded from the MMSU website or from the Philippine Government Electronic Procurement System (PhilGEPS) website.
7. For questions and inquiries, please write or email the University President, thru the BAC Chair, at the address indicated below.

Mariano Marcos State University
Quiling Sur, City of Batac
www.mmsu.edu.ph

November 22, 2022

NATHANIEL R. ALIBUYOG
BAC CHAIR

Received: _____

Received: _____

Republic of the Philippines
MARIANO MARCOS STATE UNIVERSITY
Batac, Ilocos Norte

PROJECT INFORMATION DOCUMENT

Project Title : Replacement of roofing and ceiling at LHS Guidance Office
Project Location : MMSU CTE- City of Laoag, Ilocos Norte

GENERAL INSTRUCTIONS

The project calls for the furnishing of all materials, labor, tools and equipment needed for the replacement of roofing and ceiling. The proposed project is located at the MMSU CTE LHS Bldg, Laoag City, Ilocos Norte. The said project shall be done in strict conformity with the designs, plans, drawings and other details, as well as the specifications, this Project Information Document and other related contract documents prepared and approved for this project. It is highly recommended that the contractor shall conduct site inspection for them to have an idea on the existing condition of the building.

It also calls for the employment of men power with the appropriate skills and expertise to undertake the specific items of work and to enable the contractor to produce and deliver to the satisfaction of the owner the needed services and output required of this undertaking. The contractor shall provide a site engineer, electrical practitioner and shall have adequate and readily available construction equipment to be utilized during the construction activities.

General Instructions

The contractor shall ensure that the construction activities must not interfere, obstruct and disturb any on-going operation of the building and other facilities; hence, the contractor shall isolate the working area from the other portions of the building. In addition, the contractor shall be required to provide its own water and power supply system needed in the proper execution of the various works for the duration of the contract.

I. DEMOLITION WORKS

1. This item shall include removal of existing roofing sheets and bended accessories.
2. Interior and exterior ceiling of guidance office shall be removed.
3. All necessary portions to be demolished for the completion of the project shall be included in this scope of work.
4. Disposal of waste shall be done by the contractor, subject for the inspection of the university disposal committee.
5. Prior to demolition, the area shall be subject for inspection of proper authorities for documentation.

II. ROOFING WORKS

1. Roofing works shall include the furnishing of all labor, material, and equipment, and performing all operations necessary to execute the project.
2. The coverage of this work shall only be at the guidance office of LHS Bldg. as shown in the plan.
3. Material to be used shall be 0.40mm thick rib type roofing sheet with 0.40mm thick bended accessories.
4. Standard installation of roofing sheets and accessories shall be followed.
5. All materials shall be subject for approval prior to installation.
6. Electrical lines and fixtures shall be restored same as existing layout.
7. Upon completion of this work, leak test shall be conducted to ensure quality of work.

III. CEILING WORKS

1. This scope of work includes installation of interior ceiling and roof eaves of guidance office.
2. All ceiling frames shall be properly anchored to avoid sagging of ceiling.
3. Ceiling elevation shall be the same as existing ceiling line.
4. Entrance door shall also be replaced including hinges and knobs.
5. Materials to be used shall be in strict compliance with the approved specification.

IV. PAINTING WORKS

This item shall consist of furnishing all paints, enamels and other products to be used including labor, tools and equipment required for painting of walls, ceiling, and baseboard. The contractor prior to commencement of the work shall examine the surfaces to be applied with paints, enamels, lacquers and other related products in order not to jeopardize the quality and appearance of painting or finishing work. All surfaces to receive paint should be cleaned and in proper condition. Hairline cracks and unevenness shall be patch and sealed with approved putty or patching compound. Woodwork shall be hand-sanded smooth and dusted clean, apply putty on joints and uneven portions. For all paintworks, colors shall be approved first before application. Provide color samples for better visual and appreciation of end user.

After all the works have been completed, the surrounding immediate areas affected in the prosecution of the project shall be cleaned and cleared of all excess materials and debris, temporary structures, facilities and utilities used during the construction period. All spillages and scattered caused by the painting works, grouts, adhesives, as well as markings and signage shall likewise be removed to the full satisfaction of the Owner.

A. Time is a very important factor in the implementation of this project and as such, all works indicated in the plans, specifications and in this document shall be fully completed within **21 calendar days** from receipt of the Notice to Proceed.

B. Before final acceptance by the end-user, the Contractor shall post a warranty security in accordance with the following schedule as prescribe in Section 62.2.3.3 of RA 9184



Form of Warranty Security	Amount of Warranty Security (Equal to percentage of the Total Contract Price)
a) Cash or Letter of Credit issued by a Universal or Commercial Bank: Provided, however, that the LC shall be confirmed or authenticated by a Universal or Commercial Bank, if issued by a foreign bank.	Five percent (5%)
b) Bank guarantee confirmed by a Universal or Commercial Bank.	Ten percent (10%)
c) Surety bond callable upon demand issue by GSIS or a surety or insurance company duly certified by the Insurance Commission as authorized to issue such security.	Thirty percent (30%)

to cover warranty against structural defects to cover the following periods as follows in accordance with Section 62.2.3.2

- C. Permanent Structures (15 years)
- D. Semi-Permanent Structures (5 years)
- E. Other Structures (2 years)

C. The Approved Budget for the Project to be bid is **One Hundred Seventy Five Thousand Two Hundred Fifty and 84/100 Pesos Only (Php. 175,250.84)**

Prepared by:

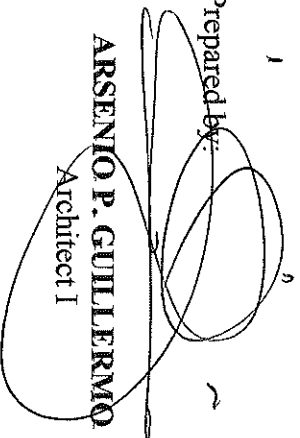
ARSENIO P. GUILLERMO
 Architect I

Checked by:

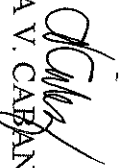
AIDA V. CABANG
 Architect IV, Chief Planning

Noted by:

ROMEO B. DHILAO
 Director, IPDO



Republic of the Philippines
MARIANO MARCOS STATE UNIVERSITY
City of Batac, 2906, Ilocos Norte

BILL OF QUANTITIES

Project Title: Replacement of roofing and ceiling at LHS Guidance Office

Item No.	Description	Quantity	Unit
1.0	Demolition Works Removal of roofing sheets, flashing, roof eaves, and interior ceiling	1.00	lot
2.0	Roofing Works Roofing sheet, flashing, gutter	1.00	lot
3.0	Ceiling Works Interior Ceiling and roof eaves	42.55	sq. mtrs.
4.0	Painting Works Painting of ceiling, walls, baseboard	84.61	sq. mtrs.

Prepared by:

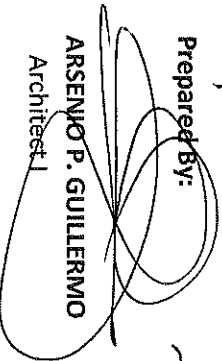
ARSENIO P. GUILLERMO
Architect I

Checked by:

AIDA V. CABANG
Architect IV, Chief Planning

Recommending Approval:

ROMEO R. PULIDO
Director-PPDO

Republic of the Philippines
MARIANO MARCOS STATE UNIVERSITY
City of Batac, Ilocos Norte

SPECIFICATION FOR Replacement of roofing and ceiling at LHS Guidance Office

ITEM NO.	DESCRIPTION
I.	<p>Demolition Works</p> <p>Coverage:</p> <ol style="list-style-type: none">1. Removal of existing roofing sheets, flashing2. Removal of ceiling.
II.	<p>Roofing Works</p> <p>Coverage: Replacement of roofing sheets and banded accessories</p> <p>Materials:</p> <ul style="list-style-type: none">1070mmx0.40mm thk Rib Type Roofing (green)0.40mm thk Ridge Cap (green)0.40mm thk Wall Flashing0.40mm thk Box Flashing0.40mm thk Box GutterTekscrew 12x65mmBlind Rivet 5/32x1/2"Silicone Sealant
III	<p>Ceiling Works</p> <p>Coverage: Replacement of ceiling and roof eaves</p> <p>Materials:</p> <p>Interior Ceiling and door</p> <ul style="list-style-type: none">19mmx50mmx0.4mm thk Furring Channel12mmx38mmx0.8mm thk Carrying Channel25mmx25mmx0.4mm thk Wall AngleW-ClipBlind Rivet 5/32x1/2"Blind Rivet 5/32x3/4"Concrete Nail 1"Hardiflex Board (4ftx8ftx4.5mm)0.90mx2.10m Panel Door (varnished finished)3"x4" Ball Bearing Butt Hinges (satin finish)Lever Type Door KnobDiamond Cutting Disk 4" <p>Roof Eaves</p> <ul style="list-style-type: none">7"x0.40mm thk Spandrel (white) with ventFascia Cover MouldingWall AngleBlind Rivet 5/32x1/2"Concrete Nail 1"

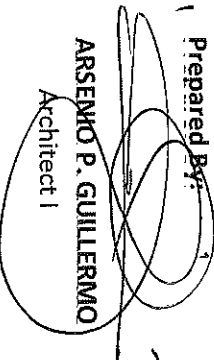

N.	<p><i>Painting Works</i></p> <p>Coverage: 1. Painting of walls, ceiling, and baseboard</p> <p>Materials:</p> <ul style="list-style-type: none"> Flat Latex White (<i>ceiling</i>) Semi Gloss Latex Off White (<i>wall</i>) Semi Gloss Latex Brown (<i>baseboard</i>) Masonry Putty Paint Brush 2" Roller Brush 7" Roller Brush 4" Paint Pan All Purpose Epoxy A&B Putty Knife Patching Compound Sandpaper #120 (oakey) Sandpaper #80 (oakey)
----	--

Prepared By: 
ARSENIO P. GUILLERMO
 Architect I

Checked by:

AIDA V. CABANG
 Architect IV, Chief Planning

Recommending Approval:

ROMEO R. TUBULAN
 Director



ARCHITECT
ARSENIO P. GUILLERMO

CHECKED/REVIEWED BY:

REPLACEMENT OF ROOFING AND
CEILING AT LHS GUIDANCE OFFICE

LOCATION: MMSU-CTE, CITY OF LAOAG, ILOCOS NORTE

RECOMMENDING AGENCY: MMSU-CTE

DIRECTOR
ROMEO B. JUDILAO

APPROVED BY:

PROJECT TITLE:

CONFIRME:

SHEET NO. ENT:

SHEET NO.:

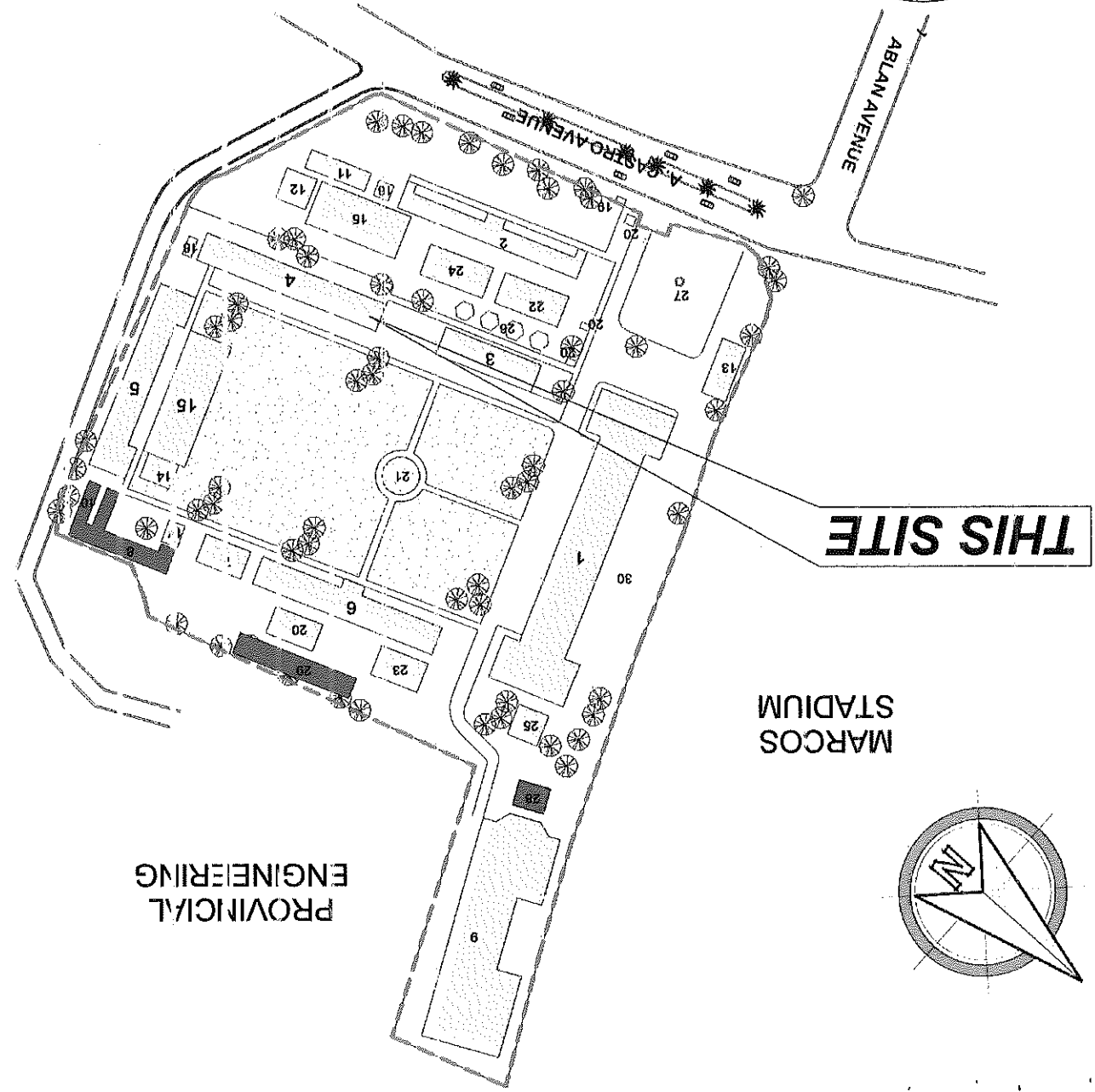

THIS SITE

MARCOS
STADIUM

PROVINCIAL
ENGINEERING

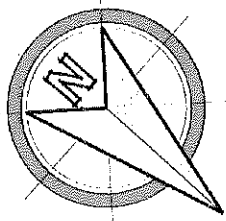

- LEGEND:**
- 1. ADMINISTRATION BUILDING
 - 2. 1STC BUILDING
 - 3. TWO STOREY MULTI PURPOSE BLDG.
 - 4. HIGH SCHOOL BLDG.
 - 5. LABORATORY ELEMENTARY SCHOOL
 - 6. CTEX BUILDING
 - 7. COMPUTER BUILDING
 - 8. PRACTICAL ARTS (TO BECOME THE CTE TEACHING LABORATORY SCIENCE BLDG.
 - 9. MMSU DORMITORY
 - 10. LHS BLDG. 2
 - 11. CAT BUILDING
 - 12. DWFB RADYONG BAYAN
 - 13. PARKING GARAGE
 - 14. STAGE
 - 15. COVERED BASKETBALL COURT
 - 16. ELEVATED WATER TANK
 - 17. PUMP HOUSE
 - 18. MALE AND FEMALE CR
 - 19. WAITING SHEI
 - 20. CARPENTRY
 - 21. FLAGPOLE
 - 22. STUDENT CENTER
 - 23. FACULTY AND EDUCATIONAL MEDIA CENTER (FEMC)
 - 24. BALAY TI ALUMNI
 - 25. RABBI STATION
 - 26. KIOSK
 - 27. NORMALTE PARK
 - 28. PROPOSED THREE STOREY TRAINING CENTER
 - 29. PROPOSED THREE STOREY ACADEMIC BLDG.
 - 30. EXISTING PARKING AREA
 - EXISTING BUILDINGS
 - UPCOMING INFRASTRUCTURE PROJECTS



DRAWN BY:

ARSENIO P. GUILLERMO
ARCHITECT I

SCALE 1:100 MTRS.

FLOOR PLAN

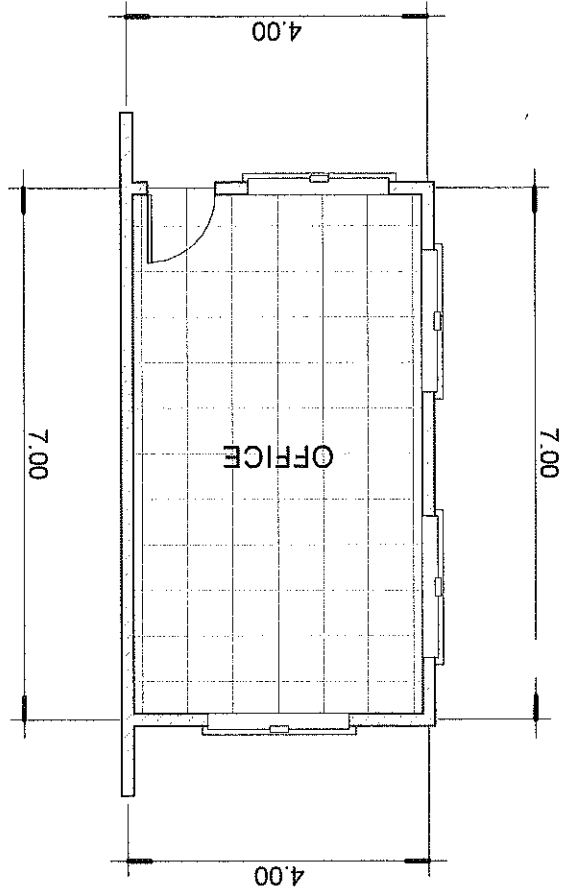

- SCOPE OF WORKS
1. REPLACEMENT OF ROOFING, FLASHING AND GUTTER.
 2. REPLACEMENT OF CEILING EAVES.
 3. REPLACEMENT OF OFFICE CEILING.
 4. REPAINTING OF INTERIOR WALLS.

PROJECT TITLE:

REPLACEMENT OF ROOFING AND CEILING AT
LHS GUIDANCE OFFICE

LOCATION: MMSU-OTE LHS BLDG. LAOAG CITY, ILOCOS NORTE

SCALE 1:100 MTRS.

FRONT ELEVATION

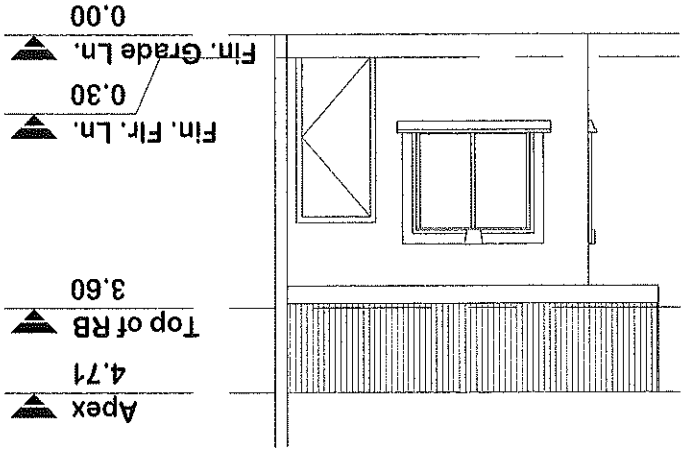

PERSPECTIVE

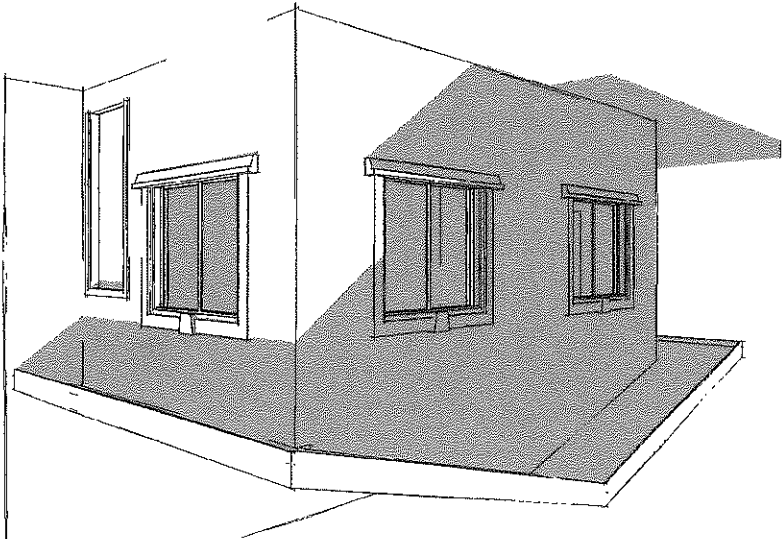

CONFORME:

ARIS REYNOLDO CAJIGAL
Dean, OTE

RECOMMENDING APPROVAL:

ROMEO R. BULBULAO
DIRECTOR, PFDG

APPROVED BY:

SHIRLEY C. AGRUPIS
UNIVERSITY PRESIDENT

SHEET CONTENT:

SCALE 1:100 MTRS.

REAR ELEVATION

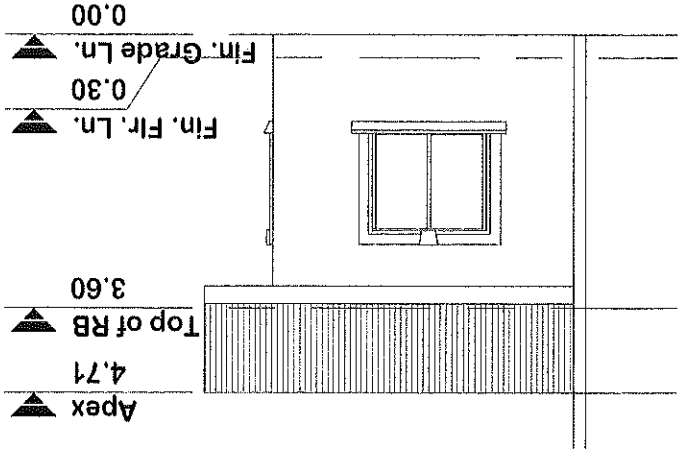

LEFT SIDE ELEVATION

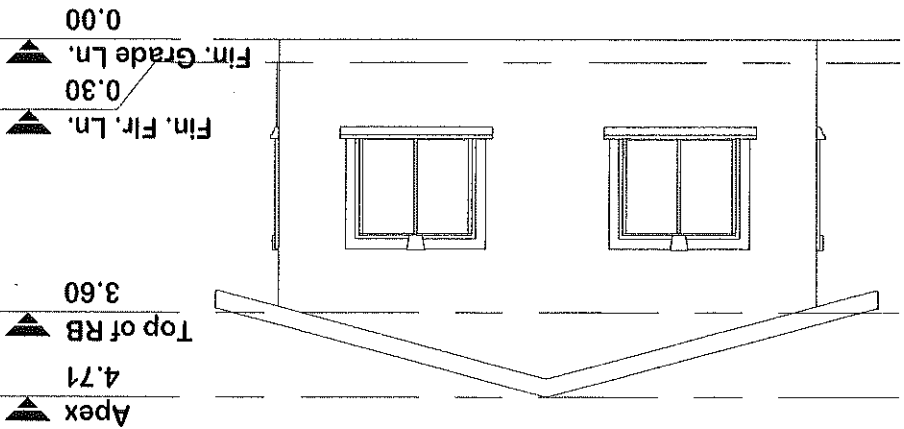



DRAWN BY: **ARSENIO P. GUILLERMO**
 ARCHITECT
 CHECKED/REVIEWED BY: *[Signature]*
 ARCHITECT IN CHIEF PLANNING
AIDA V. CABANG

PROJECT TITLE: **REPLACEMENT OF ROOFING AND CEILING AT
 LHS GUIDANCE OFFICE**
 LOCATION: **MMSU-CTE LHS BLDG, LAOAG CITY, ILOCOS NORTE**

RECOMMENDING APPROVAL: *[Signature]*
ROMEO R. DUTUAÑO
 DIRECTOR, PFD
 CONFORME: *[Signature]*
ARIS REYNOLD V. CAJIGAL
 Dean, CTE

APPROVED BY: *[Signature]*
SHIRLEY C. ARRUPIS
 UNIVERSITY PRESIDENT

REFLECTED CEILING PLAN
 SCALE: 1:100 METERS

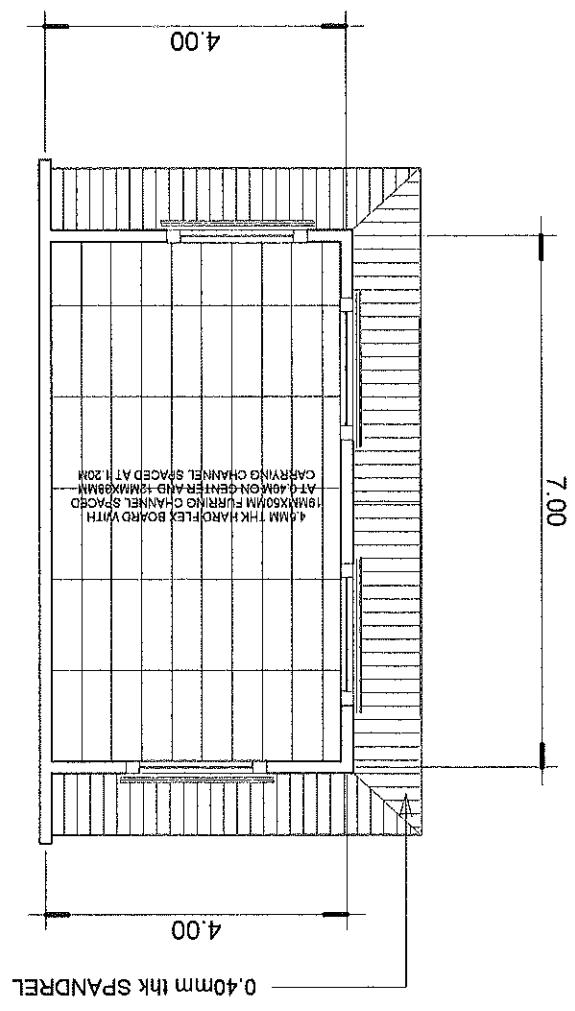

DETAIL OF ROOFING
 SCALE: 1:50 METERS

